



HENSEL

Technische Angaben

Spezifikationen und -Kategorieleistungen
 nach den Normen und Bestimmungen



Abmessungen (Standard)
 ...
 ...
 ...

Kreuzschraubenzieher
Arbeits-Kreuzschraubenzieher ASM
 mit Zapfenformung und Doppelnut
 Schutzart IP 65
 Gütebestimmung VDE 0471 T2 600°C LL V2

Arbeits-Kreuzschraubenzieher ASM
 mit Zapfenformung und Doppelnut
 Schutzart IP 65
 Gütebestimmung VDE 0471 T2 600°C LL V2

Einseitiges Schraubenzieher ESM
 Schutzart IP 65
 Einseitiges Schraubenzieher ESM
 Drehung: Gegen den Uhrzeigersinn
 Gegen den Uhrzeigersinn

Stummelschraubenzieher STM
 Schutzart IP 65
 Stummelschraubenzieher STM
 Drehung: Gegen den Uhrzeigersinn
 Gegen den Uhrzeigersinn



Technical information

Technical data

Technical data

Material properties	424
Directive 2011/65/EC (RoHS), Regulation (EC) No 1907/2006 REACH	425
Degrees of protection provided by enclosures (IP Code)	426 - 427
Recommendation for outdoor installations, humid and wet areas and locations	428
Formation of condensed water and retaliatory actions	429 - 430
International Short Forms of Types of Conductors	431
IK-Code	431
Outside diameter of conventional cable cross-sections	432
Short Forms of Cables	432
Assignment of cable outside diameters to cable glands	433
Standards	433
Terminal Technology	434 - 435
Preparation of Aluminum Conductors	436
Tested quality	437
Definition of terms	438
EC Declaration of Conformity	439
Further technical information can be found on the Internet www.hensel-electric.de -> Products	

Technical data

Material properties

Products	Material used	Glow wire test IEC 60 695-2- 11	UL Subject 94	Temperature resistance	Chemical resistance ¹⁾					
					Acid 10 %	Lye 10 %	Alcohol	Petrol (MAK) ²⁾	Benzene (MAK) ²⁾	Minerar oil
DK 02.. / DK 04.. / DK 06.. / DK 10.. / RK 02.. / RK 04.. / DN	PP (polypropylene)	750 °C	V-2	-25 °C / +80 °C	+	+	+	0	-	0
DK 16.. / DK 25.. / DK 35.. / DK 50..	PC (Polycarbonat)	750 °C	V-2	-40 °C / +120 °C	+	+	0	+	-	+
KF G / KF H / KF B / KF C WP / bottom parts of Mi ... / FP ... / SB FK 04.. / FK 06.. / FK 16..	PC (polycarbonat) (with GFS)	960 °C	V-0	-40 °C / +120 °C	+	+	0	+	-	+
K 12.. / K 24.. lid Mi ... / SB ... / door and lid KV ... / door and lid KV PC .. / door and frame FP ... / hinged lid KG ...	PC (Polycarbonat)	960 °C	V-0	-40 °C / +120 °C	+	+	0	+	-	+
DE / DP KV / KG	PS (Polystyrol)	750 °C	V-2	-40 °C / +70 °C	+	+	+	-	-	0
Sealings DK 02.. / DK 04.. / DK 06.. / DK 10.. / DK 16.. / RK 02.. / RK 04.. / KF 02.. / KF 04.. / KF 06.. / KF 10.. / KF 16.. DP ... / DPC ... / DE ... / KV ... / KV PC ... / KF PV ... / Mi FP ... / FP FG ... ESM .. / STM .. / EDK .. / EDR .. / KST .. / DPS .. / ERA .. / EKA .. / EVS ..	TPE (Thermo- plastisches Elastomer)	750 °C	-	-25 °C / +100 °C	+	+	+	0	0	0
Sealings DK 25.. / DK 35.. / DK 50.. / KF 25.. / KF 35.. / KF 50.. K ... / KV ... / KV PC ... / Mi ... / FP ... / SB ...	PUR (polyurethane)	-	-	-25 °C / +80 °C	0	+	0	0	-	+
AKM .. / ASS .. / BM ...	PA (polyamide)	960 °C	V-0	-40 °C / +100 °C	+	0	+	+	+	+
AKS .. KBM .. / KBS ..	PA (polyamide)	960 °C	V-2	-40 °C / +100 °C	+	0	+	+	+	+
AVS .. / AFM ..	PA (polyamide)	750 °C	V-2	-40 °C / +100 °C	+	0	+	+	+	+
Sealings AKM .. / AKS .. / AKS ..	CR/NBR (polychloroprene - nitrile rubber)	-	-	-20 °C / +100 °C	+	+	+	0	-	0
Sealings - inner part ASS ..	TPE (Evoprene)	-	-	-30 °C / +100 °C	+	-	+	-	-	-
Sealings - outer part ASS ..	CR (chloroprene rubber)	-	-	-30 °C / +100 °C	+	+	+	0	-	0
Sealings KBM .. / KBS ..	EPDM ethylene propylene diene monomer rubber	-	-	-40 °C / +130 °C	+	+	+	-	-	-

(+ = resistance; 0 = partially resistance; - = not resistant)

As at: January 2017

1) The specifications on chemical resistance are a general guide. In individual cases it may be necessary to check resistance in combination with other chemicals and ambient conditions (temperature, concentration, etc.)

2) (MAK) - Maximum allowable concentration (work place)

Technical data

RoHS, REACH

Directive 2011/65/EU (RoHS)

We state all these details according to the best of our knowledge. They correspond to the present state of the art. This information is not to be understood as a warranty in the sense of warranty law.

Under the intended use, our products do not fall within the scope of the Electrical Equipment Act (Electrical and Electronic Equipment).

The following product series comply with Directive 2002/65/EC (RoHS):

- **ENYCASE**® DK Cable junction boxes
- **ENYBOARD** KV Small-type distribution boards
- **ENYSTAR**® Distribution boards with door (empty enclosures, circuit breaker boxes)
- **ENYMOD** Mi Power distribution boards (empty boxes, circuit breaker boxes)
- **ENYFLEX** Empty enclosures in according with IEC 62208
- **ENYFIT** Cable entry systems

Regulation (EC) No 1907/2006 REACH

Gustav Hensel GmbH & Co. KG meets the requirements set by REACH (EG) No. 1907/2006. We shall inform you in the framework of our business relations about the changes to our products resulting from REACH and agree on suitable measures on a case-by-case basis.

As far as article 33 of REACH is concerned, we hereby inform you that our products and their packaging materials do not contain any substances on the candidate list according to article 59 (1, 10) of the above-mentioned regulation in a concentration above 0.1 % weight by weight (as of 12/17/2015).

Technical data

Degrees of protection provided by enclosures (IP Code)

Degrees of protection according to IEC 60 529

Degree of protection of electrical equipment

Electrical equipment must be protected for safety reasons from external influences and conditions. Enclosures provide the protection of electrical equipment against access to hazardous parts and against solid foreign objects, as well as dust, humidity and water.

The international standard IEC 60 529, the German standard *DIN EN 60 529 / VDE 0470 Part 1 September 2000* with the title

“Degrees of protection provided by enclosures (IP Code)”, form the basis for the determination and designation of the degree of protection.

The degree of protection provided by an enclosure is proven by means of standardized testing methods.

The becoming “aged” of test samples before carrying out the actual type tests are part of the standardized testing methods.

Ageing is made by an more-active increased thermal treatment.

1st characteristic numeral: Protection against foreign solid objects and direct contact		Additional letter		Application
Meaning for the protection of equipment against ingress of solid foreign objects and of persons against access to hazardous parts with (non-protected) back of hand, finger, tool or wire.		Additional letter where the actual protection against access to hazardous parts is higher than that indicated by the 1st characteristic numeral (e.G. IP 20C)		
	Protection against ingress of solid foreign objects ...	Protection against access to hazardous parts with ...	Short form: Protection against access with ...	Symbol
IP 0X	non-protected	non-protected		
IP 1X	solid foreign objects ≥ 50 mm Ø	the back of a hand	A	the back of the hand
IP 2X	solid foreign objects ≥ 12.5 mm Ø	a finger	B	a finger
IP 3X	solid foreign objects ≥ 2.5 mm Ø	a tool ≥ 2.5 mm Ø	C	a tool ≥ 2.5 mm Ø
IP 4X	solid foreign objects ≥ 1 mm Ø	a wire ≥ 1 mm Ø	D	a wire ≥ 1 mm Ø
IP 5X	dust-protected	with any auxiliary equipment (wire)		
IP 6X	dust-tight	contact with any auxiliary equipment (wire)		

Meaning of the first characteristic numeral

The first characteristic numeral indicates, to what extent the enclosure provides protection for persons against the access to (affecting of) hazardous parts. This protection is reached, when the penetration into an enclosure of a part of the body or a foreign object, which is held by a person, is prevented or limited. At the same time the enclosure provides protection of equipment against the penetration of solid foreign objects. This is the reason for having two descriptions and two definitions to each first characteristic numeral.

Meaning of the second characteristic numeral

The second characteristic numeral indicates the protection of the enclosure against ingress of water with harmful effects on the electrical equipment.

The marking system consists of the code letters **IP** and two following characteristic numerals.

Example:

IP 6 7



2nd characteristic numeral: Protection against ingress of water with harmful effects

IP X0	IP X1	IP X2	IP X3	IP X4	IP X5	IP X6	IP X7	IP X9
Non-protected	Protection against vertical dripping water	Protected against dripping water, when the housing is tilted up to 15°	Protection for occasional cleaning procedures, not direct spraying of the equipment (spraying water)	Protection for occasional cleaning procedures, not direct spraying of the equipment (splashing water)	Protection of operational processes, not direct spraying of the equipment (water jets)	Protection of operational processes, not direct spraying of the equipment (powerful water jets)	Protection against the effects of temporary immersion in water	Protection against cleaning processes (direct jet) and high water temperatures
	☰	☰	☰	☰	☰☰	☰☰	☰☰	
IP 20								
IP 30	IP 31							
IP 40	IP 41	IP 42	IP 43	IP 44				
				IP 54	IP 55			
					IP 65	IP 66	IP 67	IP 69

Additional letters to the IP Code

The IP Code can still be extended by additional letters. Additional letters indicate the degree of protection against access to hazardous parts. Additional letters follow the two characteristic numerals. Additional letters are only used, - if the actual protection against access to hazardous parts is higher than by the first characteristic numeral indicated; or - if only the protection against access to hazardous parts is indicated and the degree of protection against solid foreign objects is not considered. The first characteristic numeral being then replaced by an X. An enclosure shall only be designated with a stated degree of protection indicated by the additional letter if the enclosure also complies with all lower degrees of protection.

Technical data

Recommendation for outdoor installations, humid and wet areas and locations

Country-specific requirements have to be observed!

1. Requirement

Protection against ingress of water for all electrical equipment (devices) with the appropriate encapsulation (2nd characteristic numeral)

Note for outdoor installation:

Requirements of German standard DIN VDE 0100 Part 737 for compliance with IP degree of protection

1.1. Minimum requirement for electrical equipment:



„Protected outdoors“

Electrical equipment has to be protected from precipitation (like rain, snow or hail) as well as from direct sunlight.

„Non-protected outdoors“

Electrical equipment can be exposed to precipitation or direct sunlight.

With both assembly sites the climatic effects on the installed equipment must be observed, for example, high or low ambient temperatures or condensation.

1.2. Minimum requirements for electrical equipment, that must withstand higher environmental stresses:

degree of protection IP X **4**

with **non-direct** jets of water within occasional cleaning procedures, e.g. agriculture



degree of protection IP X **5**

with **non-direct** jets of water within operational cleaning procedures, e.g. carwash



degree of protection IP X **5** and additional consultation with the manufacturer:

with **direct** jets of water within occasional cleaning procedures of enclosures, e.g. butcher's shop



Country-specific requirements have to be observed!

2. Requirement of German Standard DIN VDE 0100 Part 737

4.1 Electrical equipment must be selected taking into account the external influences to which they may be exposed. Proper operation and the effectiveness of the required degrees of protection must be assured.

Note: Data from the manufacturer!

Technical data

Formation of condensed water and retaliatory actions

How does condensed water occur in enclosures with a high degree of protection?

Condensed water only forms in enclosures with a higher degree of protection than IP 54 due to temperature difference from inside to outside. Humidity can not evaporate because of the high degree of protection of the enclosure.

System switched on.

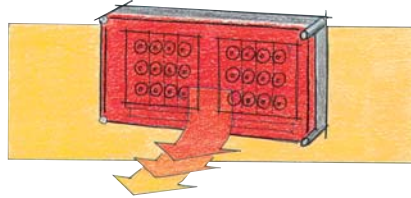

The internal temperature is higher than the external temperature due to the power dissipation of the built-in devices.

System switched on.

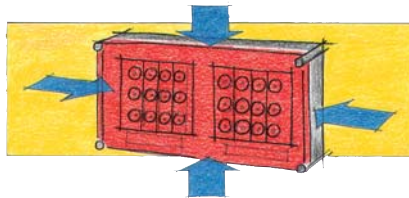

The warm air inside the enclosure attempts to accumulate moisture. This comes from outside through the seal as the enclosures are not gas-tight.

System switched off.

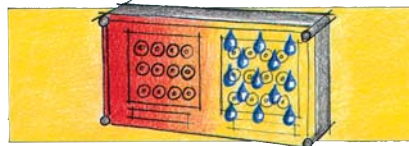

The internal temperature is reduced by cooling down the system e.g. by switching off the loads. The cooler air emits moisture which is collected as condensed water on the cooling inner surfaces.

How does condensed water occur in enclosures with a high degree of protection?

Formation of condensed water for **indoor installations:**

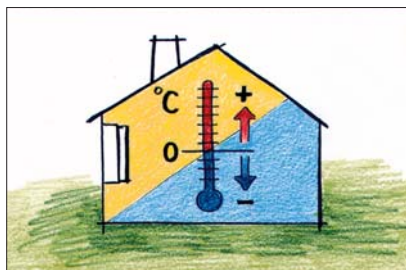

In areas where high levels of air humidity and large temperature fluctuations are expected e.g. in laundry rooms, kitchens, car washes etc.

Formation of condensed water in **protected outdoor installations** (protected against weather influences) **or unprotected outdoor installations:**



Here condensed water can be formed dependent on the weather, high air humidity, direct sunlight and temperature differences compared to the wall.

Technical data

Formation of condensed water and retaliatory actions

Measure against formation of condensation water

e. g. Cable junction boxes

1. Select the installation site (avoid temperature differences).
2. Open condensed water membrane at the lowest point of the cable junction box (maybe drill hole \varnothing 5 mm).
3. Enable exchange of air via ventilation.



Open condensation water membrane



e.g. Mi Distribution boards

Ventilation flange for vertical mounting on lateral box walls in case of extremely high inside temperature or the risk of water condensation, degree of protection IP 44.

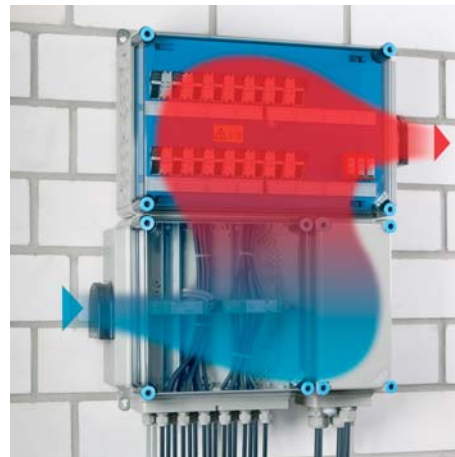

Cable entry and ventilation

Combi climate glands





Combi climate glands ensure pressure compensation between enclosure interior and ambient air via an inserted, breathable membrane and ingress of water from outside is prevented.



Technical data

International short forms of types of conductors IK code

International short forms of types of conductors

r (rigid)				f (flexible)
sol (solid)		s (stranded)		
round conductors 	sector-type conductors 	round conductors 	sector-type conductors 	flexible conductors 
RE (round single)	SE (sector, solid)	RM (round stranded)	SM (sector, stranded)	

IK Code Protection against mechanical shock (impact strength)

IK Code: Demand energy value [W] in Joules.

The European standard for enclosures EN 50298:98 includes also the IK Code for impact strength. With the DIN EN 50102 (VDE 0470 part of 100) "Degrees of protection by enclosures for electrical operational funds (equipment) against outside mechanical loads (IK Code)", is defined with the identification letters IK.

This standard regulates the methods for the description of the protection of enclosures against outside mechanical loads.

This indicates the degree of protection, which is provided by an enclosure against a mechanical load (demand energy in joules).

HENSEL tests its enclosures and enclosure systems additionally also according to this standard.

Classification of the impact strength by the IK Code

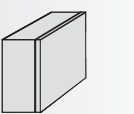
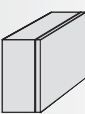
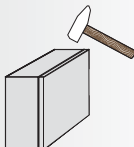
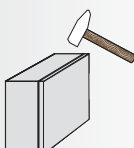
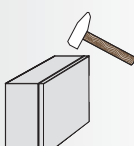
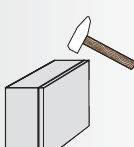
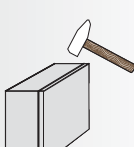
IK Code	[W] in J	
IK00	no protection	
IK01	0,14	
IK02	0,2	
IK03	0,35	
IK04	0,5	
IK05	0,7	

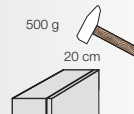
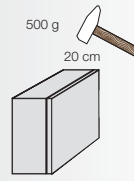
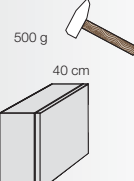
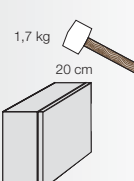
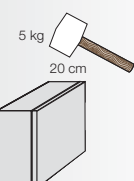
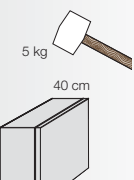
IK Code	[W] in J	
IK06	1	
IK07	2	
IK08	5	
IK09	10	
IK10	20	

Technical data

Outside diameter of conventional cable cross-sections Short forms of cables

The outside diameters are average values of different products.

Cable cross-section	NYM	NYY	NYCY NYCWY
mm ²	mm Ø	mm Ø	mm Ø
1x4	8	9	—
1x6	8.5	10	—
1x10	9.5	10.5	—
1x16	11	12	—
1x25	—	14	—
1x35	—	15	—
1x50	—	16.5	—
1x70	—	18	—
1x95	—	20	—
1x120	—	21	—
1x150	—	23	—
1x185	—	25	—
1x240	—	28	—
1x300	—	30	—
2x1.5	10	12	—
2x2.5	11	13	—
2x4	—	15	—
2x6	—	16	—
2x10	—	18	—
2x16	—	20	—
2x25	—	—	—
2x35	—	—	—
3x1.5	10.5	12.5	13
3x2.5	11	13	14
3x4	13	16	16
3x6	15	17	17
3x10	18	19	18
3x16	20	21	21
3x25	—	26	—
3x35	—	—	—
3x50	—	—	—
3x70	—	—	—
3x95	—	—	—
3x120	—	—	—
3x150	—	—	—
3x185	—	—	—
3x240	—	—	—
3x25/16	—	27	27
3x35/16	—	28	27
3x50/25	—	32	32
3x70/35	—	32-36	36
3x95/50	—	37-41	40
3x120/70	—	42	43
3x150/70	—	46	47
3x185/95	—	52	48-54
3x240/120	—	57-63	60
3x300/150	—	63-69	—

Cable cross-section	NYM	NYY	NYCY NYCWY
mm ²	mm Ø	mm Ø	mm Ø
4x1.5	11	13.5	14
4x2.5	12.5	14.5	15
4x4	14.5	17.5	17
4x6	16.5	18	18
4x10	18.5	20	20
4x16	23.5	23	23
4x25	28.5	28	28
4x35	32	26-30	29
4x50	—	30-35	34
4x70	—	34-40	37
4x95	—	38-45	42
4x120	—	42-50	47
4x150	—	46-53	52
4x185	—	53-60	60
4x240	—	59-71	70
4x25/16	—	—	30
4x35/16	—	—	30
4x50/25	—	—	34-37
4x70/35	—	—	40
4x95/50	—	—	44.5
4x120/70	—	—	48.5
4x150/70	—	—	53
4x185/95	—	—	—
4x240/120	—	—	—
5x1.5	12	15	15
5x2.5	13.5	16	17
5x4	15.5	16.5	18
5x6	18	19	20
5x10	20	21	—
5x16	26	24	—
5x25	31.5	—	—
7x1.5	13	16	—
7x2.5	14.5	16.5	—
19x1.5	—	22	—
24x1.5	—	25	—

Short forms of cables

- NYM Light plastic-sheathed cable
- NYY Plastic-sheathed cable
- NYCY Plastic-sheathed cable with concentric conductor
- NYCWY Plastic-sheathed cable with concentric, undulated conductor

Technical data

Assignment of cable outside diameters to cable glands Standards



Outside diameter of cables		Cable entry metric
min. mm Ø	max. mm Ø	
3	6.5	AKM/ASS 12
5	10	AKM/ASS 16
6.5	13.5	AKM/ASS 20
10	17	AKM/ASS 25
14	21	AKM/ASS 32
20	28	AKM/ASS 40
25	35	AKM/ASS 50
35	48	AKM/ASS 63
5	10	AFM 16
8	13	AFM 20
11	17	AFM 25
15	21	AFM 32

Cable glands AKM/ASS

Degree of protection: IP 66/67/69
With strain relief and counternut.

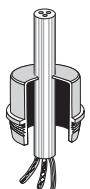

Outside diameter of cables		Cable entry metric
min. mm Ø	max. mm Ø	
4.8	11	ESM 16
6	13	ESM 20
9	17	ESM 25
9	23	ESM 32
17	30	ESM 40

Grommets ESM

Degree of protection: IP 55
Grommets are inserted into knockouts.
No nut is necessary!

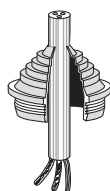

Outside diameter of cables		Cable entry metric
min. mm Ø	max. mm Ø	
3.5	12	STM 16
5	16	STM 20
5	21	STM 25
13	26.5	STM 32
13	34	STM 40

Stepped grommets STM

Degree of protection: IP 55
Stepped grommets are inserted into knock outs.
No nut is necessary!

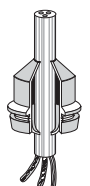

Outside diameter of cables		Cable entry metric
min. mm Ø	max. mm Ø	
5	10	EDK 16
6	13	EDK 20
9	17	EDK 25
8	23	EDK 32
11	30	EDK 40

Grommets EDK

Degree of protection: IP 65
Grommets are inserted into knock outs.
No nut is necessary!

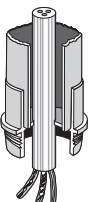

Outside diameter of cables		Cable entry metric
min. mm Ø	max. mm Ø	
Conduit		
M 16		EDR 16
M 20		EDR 20
M 25		EDR 25
M 32		EDR 32
M 40		EDR 40

Grommets for conduits EDR

Degree of protection: IP 65
Grommets for conduits are inserted into knock outs.
No nut is necessary!

Hensel cable entries comply with the following standards and regulations:



- EN 50262
Metric cable entries for electrical installations
- EN 60423
Conduits for electrical purposes - Outside diameter of conduits for electrical installations and threads for conduits and fittings
- IEC 60529
Degrees of protection provided by enclosures (IP-Code)

Technical data

Terminal technology

PE and N FIXCONNECT® terminal

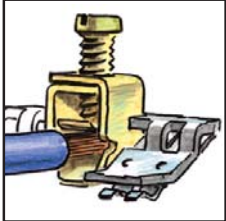
Rated connecting capacity of PE and N terminals

Clamping unit	Corresponding cross-sections/copper			
	max. number	from - to max.	max. number	from - to max.
Screw-type terminal 25 mm ²				
	1	25 mm ² , s	1	25 mm ² , f
	1	16 mm ² , s	1	16 mm ² , f
	1	10 mm ² , sol	1	10 mm ² , f
	3	6 mm ² , sol	1	6 mm ² , f
	3	4 mm ² , sol	1	4 mm ² , f
	4	2.5 mm ² , sol	1	2.5 mm ² , f
	4	1.5 mm ² , sol	1	1.5 mm ² , f
		} Tested as connecting terminal for several conductors of the same cross-sections for using in one circuit		
Plug-in terminal 4 mm ²				
	1	1.5 - 4 mm ² , sol	1	1.5 - 4 mm ² , f
			Without end ferrule; clamping unit has to be opened with a tool when conductor is inserted	









Current carrying capacity of the connecting device: 75 A

All terminals are secured against self loosening.





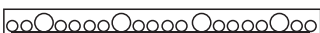



Technical data
Terminal technology

Terminal equipment and number of conductors to be connected

PE terminal for copper conductors

Number of modules	PE terminal	
	 up to 4 mm ²	 up to 25 mm ²
3	 4x4 mm ²	1x25 mm ²
4.5 6	 4x4 mm ²	2x25 mm ²
9	 8x4 mm ²	2x25 mm ²
12	 12x4 mm ²	2x25 mm ²
18	 16x4 mm ²	4x25 mm ²
24 36 (3-row) 48	 24x4 mm ²	6x25 mm ²
36 (2-row) 54	 32x4 mm ²	8x25 mm ²

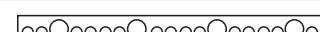
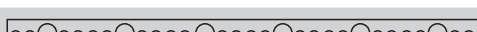
N terminal for copper conductors

Number of modules	N terminal		
	 up to 4 mm ²	 up to 25 mm ²	 plug-in jumper
3	 4x4 mm ²	1x25 mm ²	
4.5 6	 4x4 mm ²	2x25 mm ²	
9	 8x4 mm ²	2x25 mm ²	
12	 12x4 mm ²	2x25 mm ²	
18	 16x4 mm ²	4x25 mm ²	
24 36 (3-row) 48	 24x4 mm ²	6x25 mm ²	
36 (2-row) 54	 32x4 mm ²	8x25 mm ²	

Technical data

Preparation of aluminum conductors

Connection of aluminum conductors

I. Chemical basics

The special conducting characteristics of aluminum can be seen in the fact that the surface of an aluminum conductor is immediately covered in a **non-conducting oxide layer** upon exposure to oxygen.

This characteristic leads to an increase in the temporary resistance between the aluminum conductors and the terminal body.

This can lead to terminal overheating and in the worst case fire.

Despite these special conditions, aluminum conductors can be connected if the terminal used is appropriate and the following conditions are taken into consideration when connecting.

II. Special terminal requirements for the connection of aluminum conductors

The suitability of terminal for connections with aluminum conductors needs to be evaluated and confirmed by the terminal manufacturer.

1. These terminals will thus meet the requirements for an aligned **electrochemical voltage sequence**. A disintegration of the base material (aluminum) will be prevented.

2. The terminal has an appropriate shape and surface to penetrate the grease layer or a very thin oxide layer on the aluminum conductor upon connection.

III. Appropriate preparation and handling of aluminum conductors



1. The non-insulated conductor ends need to have the oxide layer carefully scraped clean using a knife for example. In doing so no files, sand paper or brushes may be used.



2. Immediately after removing the oxide layer, the conductor end needs to be rubbed with an acid and alkali free grease such as technical vaseline and then immediately connected to the terminal. This in turn prevents oxygen from forming a non-conducting oxide layer.



3. Due to the flow tendency in aluminum the terminals need to be tightened before start up and after the first **200 operating hours** (note the appropriate torque).



4. The steps listed above need to be repeated if the conductor is removed and re-connected. I.e. the conductor has to be scraped again, greased and immediately connected, because it will be connected at a different position.

Technical data

Tested quality

Test for dust protection

indicated by the first characteristic numerals 5 and 6 in accordance with IEC 60529



Test for protection against water

in accordance with IEC 60529 indicated by the characteristic numeral

7: temporary immersion

6: with powerful water jets,

4: splashing water

1: drip box



Test with vertical hammer

in accordance with IEC 60068-2-75

Test of screw-type clamping units

against loosening in accordance with IEC 60998-2-1



Glow wire test

in accordance with IEC 60695-2-11



Tests in the climatic test cabinet

according to IEC 60068-1
Resistance of materials against certain environmental influences such as heat, cold, humidity



Environmental testing -

Salt mist test in accordance with IEC 60068-2-11

Technical data

Definition of terms

Definition of Terms

Rated values for setting up low-voltage switchgear are given in the standard IEC 61 439-1

Rated voltage (U_n)

highest nominal value of the a.c. (r.m.s.) or d.c. voltage, declared by the assembly manufacturer, to which the main circuit(s) of the assembly is (are) designed to be connected.

Rated operational voltage (U_o) (of a circuit of an assembly)

value of voltage, declared by the assembly manufacturer, which combined with the rated current determines its application.

Rated insulation voltage (U_i)

r.m.s. withstand voltage value, assigned by the assembly manufacturer to the equipment or to a part of it, characterising the specified (long-term) withstand capability of the insulation.

Rated impulse voltage (U_{imp})

impulse withstand voltage value, declared by the assembly manufacturer, characterising the specified withstand capability of the insulation against transient overvoltages.

Rated current (I_n)

value of current, declared by the assembly manufacturer taking into consideration the ratings of the components, their disposition and application, which can be carried without the temperature-rise of various parts of the assembly exceeding specified limits under specified conditions.

Prospective short circuit current (I_{cp})

current which flows when the supply conductors to the circuit are short-circuited by a conductor of negligible impedance located as near as practicable to the supply terminals of the assembly.

Rated peak withstand current (I_{pk})

value of peak short-circuit current, declared by the assembly manufacturer, that can be withstood under specified conditions.

Rated short-time withstand current (I_{cw})

r.m.s value of short-time current, declared by the assembly manufacturer, that can be carried without damage under specified conditions, defined in terms of a current and time.

Rated current of the assembly (I_{nA})

The rated current of the assembly is the smaller of:

- the sum of the rated currents of the incoming circuits within the assembly operated in parallel;
- the total current which the main busbar is capable of distributing in the particular assembly arrangement.

This current shall be carried without the temperature rise of the individual parts exceeding the limits specified in the standard.

Rated current of a circuit (I_{nc})

The rated current of a circuit is stated by the assembly manufacturer, taking into consideration the ratings of the devices within the circuit, their disposition and application. This current shall be carried without the temperature rise of the various parts of the assembly exceeding the limits specified in the standard when the circuit is loaded alone.

Rated diversity factor (RDF)

per unit value of the rated current, assigned by the assembly manufacturer, to which outgoing circuits of an assembly can be continuously and simultaneously loaded taking into account the mutual thermal influences.

Technical data
EC Declaration of conformity



Erklärung der EG-Konformität
Declaration of EC Conformity

Nr./No. K-2016-12

Das Produkt / Typ
 The product / Type

FK 0402, FK 0404, FK 0604, FK 0606,
 FK 1606, FK 1608, FK 1610, FK 1616
 FK 9025, FK 9105, FK 9255, FK 9259
 FK 7045, 7105, FK 7165
 FK 6505

Hersteller
 Manufacturer

Gustav Hensel GmbH & Co. KG
 Gustav-Hensel-Strasse 6
 57368 Lennestadt

Beschreibung
 Description

Kabelzweigkästen mit Funktionserhalt E30-E90
 cable junction boxes tested for intrinsic fire resistance E30-E90

auf das sich diese Erklärung bezieht, stimmt mit folgenden Normen oder normativen Dokumenten überein:
 to which this declaration relates is in conformity with the following standard(s) or normative document(s):

DIN EN 60670-22
 EN 60670-22
 IEC 60670-22
 DIN 4102-12

und entspricht den Bestimmungen der folgenden EG-Richtlinie(n):
 and is in accordance with the provisions of the following EG-directive(s)

Niederspannungs-Richtlinie 2014/35/EG
 Low voltage directive 2014/35/EU

RoHS Richtlinie 2011/65/EG
 RoHS directive 2011/65/EU

Diese Konformitätserklärung entspricht der Europäischen Norm EN 17050-1 „Allgemeine Anforderungen für Konformitätserklärungen von Anbietern“. Diese Erklärung gilt weltweit als Erklärung des Herstellers zur Übereinstimmung mit den oben genannten internationalen und nationalen Normen.

This Declaration of Conformity is suitable to the European Standard EN 17050-1 „General requirements for supplier's declaration of conformity“. The declaration is world-wide valid as the manufacturer's declaration of compliance with the requirements of the a.m. national and international standards.

Jahr der Anbringung der CE-Kennzeichnung
 Year of affixing CE-Marking

2015

Ausstellungsdatum
 Date of issue

22.04.2016

Gustav Hensel GmbH & Co. KG

 O. Gabel
 - Technische Geschäftsführung -
 - Technical Managing Director -

Erklärung der EG-Konformität
Declaration of EC Conformity

Nr./No. K-2016-19

Das Produkt / Typ
 The product / Type

K 0102, K 0202, K 0402, K 0404, K 0501, K 0501, K 0501, K 0601, K 0601, K 0601

Hersteller
 Manufacturer

Gustav Hensel GmbH & Co. KG
 Gustav-Hensel-Strasse 6
 57368 Lennestadt

Beschreibung
 Description

Leuchtdioden für Energieerhaltung

auf das sich diese Erklärung bezieht, stimmt mit folgenden Normen oder normativen Dokumenten überein:
 to which this declaration relates is in conformity with the following standard(s) or normative document(s):

DIN EN 62020
 IEC 62020

und entspricht den Bestimmungen der folgenden EG-Richtlinie(n):
 and is in accordance with the provisions of the following EG-directive(s)

Niederspannungs-Richtlinie 2014/35/EG
 Low voltage directive 2014/35/EU

RoHS Richtlinie 2011/65/EG
 RoHS directive 2011/65/EU

Diese Konformitätserklärung entspricht der Europäischen Norm EN 17050-1 „Allgemeine Anforderungen für Konformitätserklärungen von Anbietern“. Diese Erklärung gilt weltweit als Erklärung des Herstellers zur Übereinstimmung mit den oben genannten internationalen und nationalen Normen.

This Declaration of Conformity is suitable to the European Standard EN 17050-1 „General requirements for supplier's declaration of conformity“. The declaration is world-wide valid as the manufacturer's declaration of compliance with the requirements of the a.m. national and international standards.

Jahr der Anbringung der CE-Kennzeichnung
 Year of affixing CE-Marking

2016

Ausstellungsdatum
 Date of issue

12.10.2016

Gustav Hensel GmbH & Co. KG

 O. Gabel
 - Technische Geschäftsführung -
 - Technical Managing Director -

Erklärung der EG-Konformität
Declaration of EC Conformity

Nr./No. K-2016-1

Das Produkt / Typ
 The product / Type

DK
 K 1.1

Hersteller
 Manufacturer

Gustav Hensel GmbH & Co. KG
 Gustav-Hensel-Strasse 6
 57368 Lennestadt

Beschreibung
 Description

Kabelzweigkästen

auf das sich diese Erklärung bezieht, stimmt mit folgenden Normen oder normativen Dokumenten überein:
 to which this declaration relates is in conformity with the following standard(s) or normative document(s):

DIN EN 60670-22
 EN 60670-22
 IEC 60670-22
 DIN 4102-12

und entspricht den Bestimmungen der folgenden EG-Richtlinie(n):
 and is in accordance with the provisions of the following EG-directive(s)

Niederspannungs-Richtlinie 2014/35/EG
 Low voltage directive 2014/35/EU

RoHS Richtlinie 2011/65/EG
 RoHS directive 2011/65/EU

Diese Konformitätserklärung entspricht der Europäischen Norm EN 17050-1 „Allgemeine Anforderungen für Konformitätserklärungen von Anbietern“. Diese Erklärung gilt weltweit als Erklärung des Herstellers zur Übereinstimmung mit den oben genannten internationalen und nationalen Normen.

This Declaration of Conformity is suitable to the European Standard EN 17050-1 „General requirements for supplier's declaration of conformity“. The declaration is world-wide valid as the manufacturer's declaration of compliance with the requirements of the a.m. national and international standards.

Jahr der Anbringung der CE-Kennzeichnung
 Year of affixing CE-Marking

2015

Ausstellungsdatum
 Date of issue

12.10.2016

Gustav Hensel GmbH & Co. KG

 O. Gabel
 - Technische Geschäftsführung -
 - Technical Managing Director -



The current status of EC Declarations of conformity is available on the Internet at www.hensel-electric.de -> Products

Technical information

Technical data