



DISTRIBUTION BOARD SYSTEMS
MADE OF POLYCARBONATE RELIABLE,
EVEN UNDER EXTREME CONDITIONS

POLYCARBONATE INSTEAD OF METAL - DURABLE, HIGHLY RESILIENT AND STABLE IN FORM

**Distribution board systems made of polycarbonate ensure maximum safety
under extreme conditions**



Key advantages at a glance:

- + High degree of mechanical load of IK 08 (5 Joule)
- + Resistant to weather and ageing
- + Corrosion-resistant
- + UV-resistant
- + High degree of form stability and high level of dimensional accuracy
- + Durable for decades
- + Combinable system



CORROSION-RESISTANCE GIVES RUST NO CHANCE

Indoors and outdoors, in extreme conditions and under heavy use fulfilling maximum performance and extreme durability

+ The advantages of polycarbonate material in comparison of metal are obvious: they can easily be shaped and processed and equivalently replace many metal workpieces. Products made of polycarbonate are accurate, durable, corrosion and temperature resistant, light and inexpensive and extremely durable. In addition, extremely weather resistant.

+ These properties make polycarbonate enclosures particularly suited in environments with rough, humid and wet conditions. They defy weather and environmental conditions at the site for many years and guarantee reliable and durable power distribution, wherever power is needed.



+ The investment for an electrical installation will not play an important role in the long term compared to the possible high costs of production loss.



Sheet steel enclosures and cabinets are extremely vulnerable to the effects of weather and corrode in harsh environments but especially in the outdoor application after few years.

HIGH IMPACT STRENGTH: STABLE, RESILIENT AND ALSO KEEPS IN SHAPE!

Distribution board systems made of polycarbonate standing up even in severe stresses.



POLYCARBONATE

Insulated enclosures

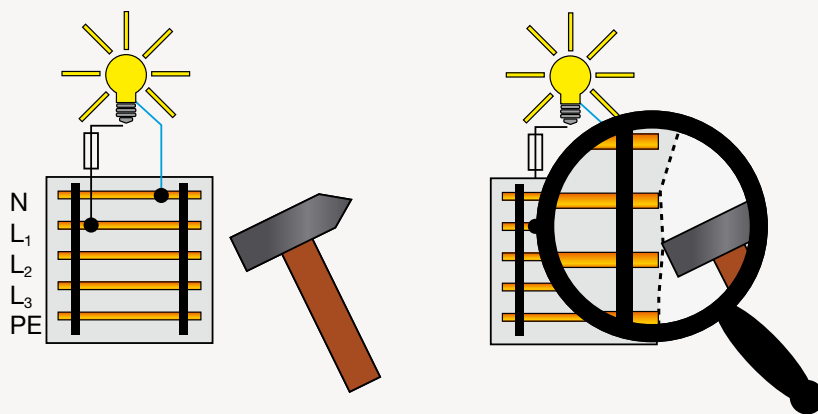

Before the stroke

Contact with live parts during the stroke



SHEET STEEL

Sheet steel enclosures

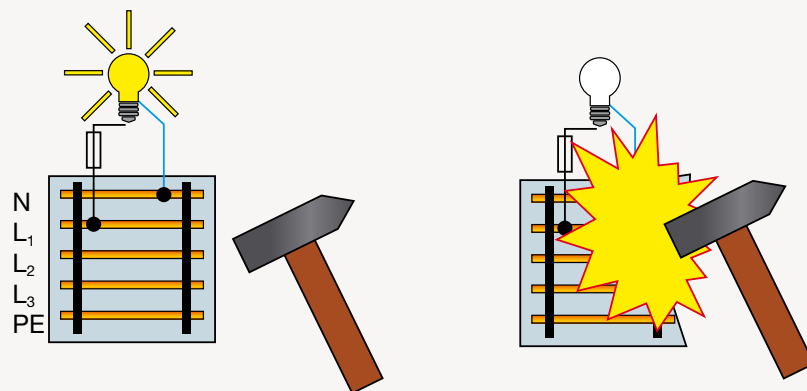

Distribution boards made of polycarbonate characterize an extremely high mechanical impact strength and hardness, IK 08 (5 Joule). This makes it a preferred material for use in areas where needs to be reckoned with strong mechanical stresses.

They have proven themselves for many years for electrical equipment of buildings, especially in harsh industrial atmospheres and demanding environmental conditions. Due to the highest possible quality they are resistant to dust and water and can withstand the harshest conditions.



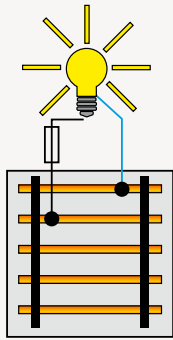

+ Dimensional stability

In an impact or any other mechanical stress polycarbonate enclosures gradually buffer and spring immediately back to the original shape. Rigidity is maintained even at higher temperatures.

+ Electrical safety

In the event of deformation by external mechanical impacts and temporarily contact with live parts polycarbonate enclosures offer a maximum protection against the hazard of electric shocks: No short circuit can occur and the protection against electric shock is maintained.

After the stroke

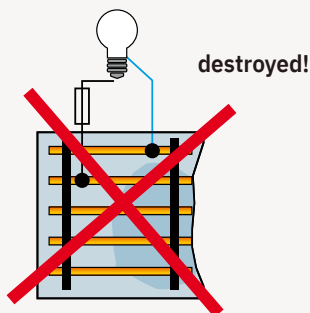

+ Deformation at impact

Sheet steel enclosures deform by external mechanical stresses such as impact, shock, etc., and not go back to the original state. This can lead to internal faults because creepage distances and clearances can not be maintained.

+ Risk of short circuit

If live parts inside a distribution board are touched by deformation of the metal enclosure, a short circuit can destroy the distribution board.

They can even take extreme weather conditions in outdoor applications without any problems.



BETTER SAFE THAN SORRY - TOTAL INSULATED ENCLOSURES REQUIRED FOR PHOTO VOLTAIC SYSTEMS ON THE DC SIDE!

IEC 60364-7-712 requires total insulation ☐ on the DC side for protection against electric shock in PV plants.



Array junction boxes must be total insulated!

Grids in building installations are generally grounded. That means, in the event of an electric fault a protective device interrupts the supply in the circuit, for example by MCB or MCCB. The DC power grid from photovoltaic systems (installation between PV module and solar inverter) is not grounded and therefore requires special measures to protect against electrical shock.





Why does IEC 60 364-7-712 require protection class II (⊞) for PV array junction boxes?

- + In grounded systems an earth fault short circuit current flows through the protective device and automatically leads to a switch-off.
 - + On the DC side of a PV installation, the maximum short circuit current is the same as the maximum operating current. This means that devices for protection against electric shock, such as MCB or fuses, do not trip, because the “fault current” is too low.
 - + As a consequence the protection against electric shock is not guaranteed in the event of an electrical fault.
 - + Total insulated equipment ⊞ ensure the protection against electric shock by encapsulating a possible electric fault by double or reinforced insulation.
- In general, total insulated enclosures (equipment of protection class II) fulfil this requirement.



For example busbars fixed on supports made of insulated material.

Total insulation is a measure to prevent an electric shock. Conductive parts in enclosures are as well insulated as additionally protected by an enclosure of insulating material.

How to provide total insulation ⊞ – protection against electric shock as required by IEC 61439-1, 8.4.4

- + The apparatus shall be completely enclosed in insulating material which is equivalent of double or reinforced insulation.
- + The enclosure shall carry the symbol ⊞ which shall be visible from the outside.
- + The enclosure shall at no point be pierced by conducting parts in such a manner that there is the possibility of a fault voltage being brought out of the enclosure.
- + The enclosure shall give at least the degree of protection IP 2XC (see IEC 60529).
- + The enclosure must be accessible only by use of tools in order to ensure the protection against direct contact of accessible live parts and the exposed conductive parts that are only accessible after the cover has been opened.

MODULAR MI SYSTEM MADE OF POLYCARBONATE

for the assembly of power switchgear and controlgear assemblies (PSC) up to 630 A in accordance with IEC 61439-2

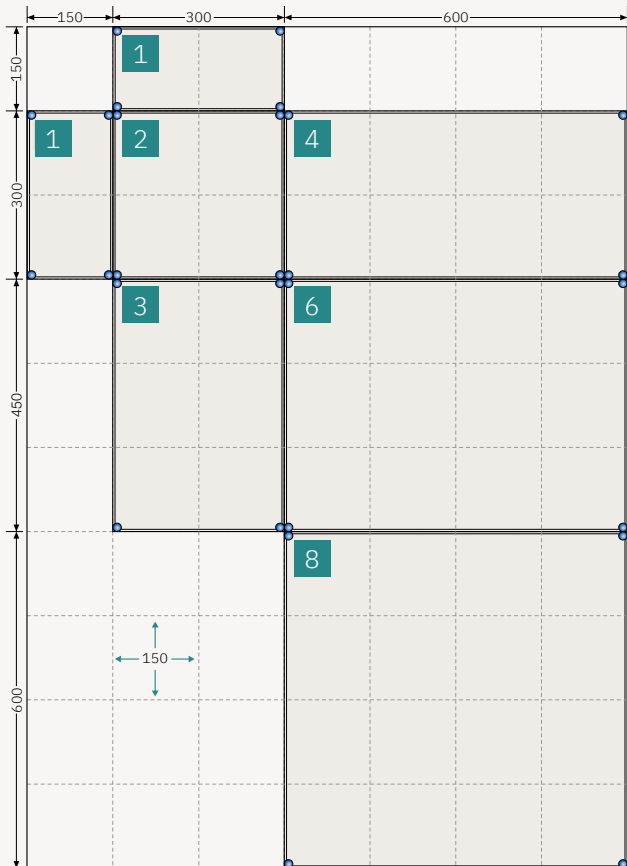

Individual or in combination

Enclosure walls
with metric cable entries



Enclosure depths for different heights of build-in device

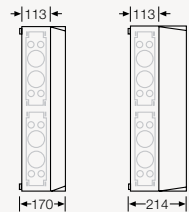

Fig. 1

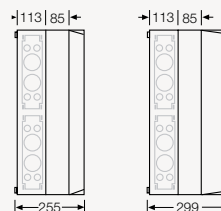

Fig. 2

+ Six box sizes can be used as individual boxes and as well combined in all directions.

+ For each built-in device the perfect enclosure depth: Different depths allow the installation of equipment of different heights (Fig. 1).

With an extension frame the depths of the enclosure sizes 4 and 8 can be extended by 85 mm (Fig. 2).

- + Clear separation of operation areas for unskilled persons and the access only for skilled persons.

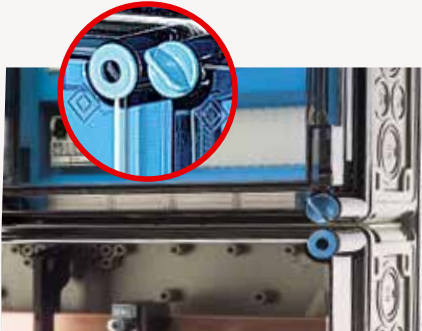

- + Operating areas for unskilled persons with hand-operation and tool-operation where only skilled persons must have access.



- + A hinged lid for simple operation of equipment.



- + Lid lock prevents unauthorised opening of lids.



Easy to combine, easy to assemble and easy to extend!

SAFETY FOR PEOPLE

Protection against direct contact of dangerous parts after opening.



+ Cover strips cover the equipment openings from accidental contact.



+ Protection covers for operating devices prevent direct contact after opening lids.



TRANSPARENT LIDS

Having everything in view.

Electrical functions that are to be monitored are visible. All enclosures have a door or a lid. Transparent and non-transparent lids / doors can be mixed within a distribution. Built-in equipment and internal wiring, which should not be seen, can be covered.



A SYSTEM THAT GROWS ALONG WITH YOUR NEEDS

Solutions on customer request



+ Easy machinability - easy to fix push buttons, CEE sockets etc.



+ The high flexibility of the modular enclosure system allows an easy upgrading of the assembly including busbar system at any time even after many years.



Shop floor distribution board with CEE sockets installed in an engineering fabrication plant.



Lighting distribution board installed in body shop of an automobile plant.

TESTED AND CERTIFIED BY ASTA

**Suitable also for typical devices or the installation of
armoured cables with earth connections**



Application:
Motor Control Centre based on Mi System

This Motor Control Center installed in a chemical plant consists of 19 feeders ranging from 2.2 KW to 25 KW including complete wiring with main incomer of 630A



Tested at ASTA for

- + Degree of protection
- + Temperature rise limits
- + Dielectric properties

- + Short circuit withstand strength
- Effectiveness of protective circuit
- + Clearance and creepage distances
- + Mechanical operation



+ Outdoor distribution board installed at the lawns of a luxury hotel.



+ Power distribution board installed at a maintenance workshop of an iron ore mine



+ Metering panel with KWH meters for an electric supply utility company

BRITISH STANDARD INSTALLATION IN INSULATED ENCLOSURES

Installation of armoured cables and earth connection in polycarbonate enclosures.

+ Grounding in connection with cable entry systems

A metal plate inside the flange is used to earth the steel wired armoured (SWA) cables via the glands in accordance with the British Standard.

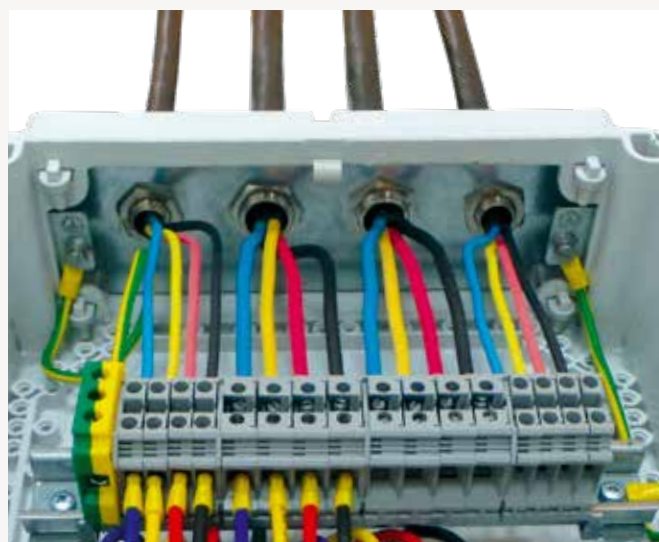
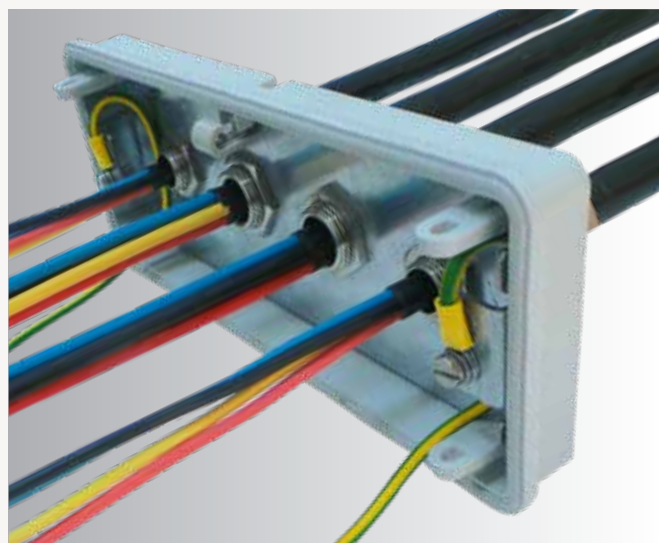

Cable entry for armoured cables via metal glands with earthing

+ Grounding of metal parts in enclosures

Only one central point must be earthed.
All metal DIN-rails are connected.

+ The rack can be removed for an easy assembling and wiring.

Integrated earth bounding in each circuit breaker box

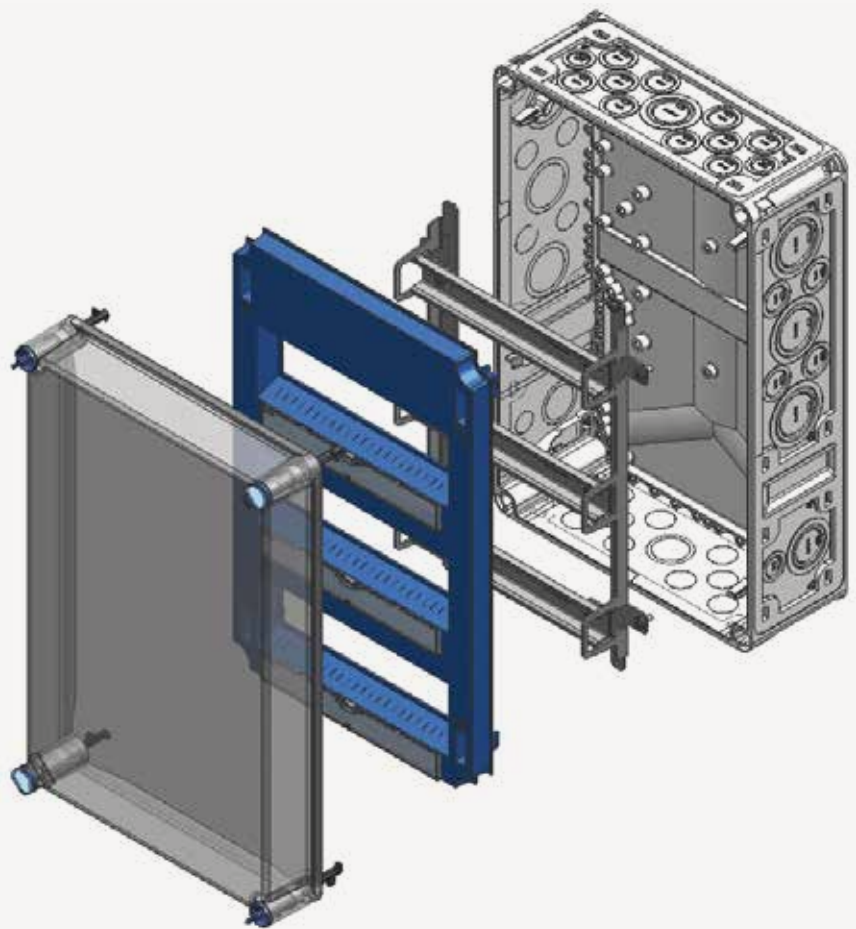

Motor control center installed in a large paper mill



Removable DIN rail rack for earth connection

OUR BEST REFEREES ARE NUMEROUS SATISFIED CUSTOMERS



Sub distribution board installed at a hydro electric plant.



Instrument enclosure at a pumping station



Power distribution boards installed at a light engineering industry



Main power distribution board installed at a foundry

Dependent on the system

Environmental conditions

for distribution boards according to IEC 61439: -5 °C up to 35 °C, max. + 40 °C; humidity: 50% at 40 °C, 100% at 25 °C for empty enclosures: - 25°C up to + 70 °C

Application area

Suitable for the protected outdoor installation - harsh environment and / or protected outdoor.

Climatic influences and effects on the equipment are to be considered.

Insulation

Insulated enclosures (Protection class II) 

Protection against foreign solid objects and direct contact

Dust-proof
Degree of protection **IP 65**

Protection against ingress of water with harmful effects

Protected against water
Degree of protection **IP 65**

Electrical parameters

Rated current: up to 630 A
Rated insulation voltage: 690 V a.c., 1000 V d.c.*, IEC 60664

* The rated insulation voltage is possibly reduced by the installed equipment technology

Dependent on the material

Burning behaviour

Glow wire test 960°C in accordance with IEC 60695-2-11, flame-retardant, self-extinguishing, UL Subject 94, V-2

UV resistance

UV resistance according to IEC 61439-1

Chemical resistance

Resistance against acid 10% and lye 10%, petrol and mineral oil

Toxic behaviour

Silicone- and halogen-free



Lighting control distribution boards in use at a mobile phone manufacturing plant

IN USE
ALL OVER THE WORLD



High mast lighting distribution board at a container yard



Main power distribution board for a petrol station

ENYGUIDE – THE 3D CONFIGURATOR FOR MI- AND ENYSTAR DISTRIBUTORS

The intuitive ENYGUIDE 3D planning tool supports installers, electrical planners and electrical wholesalers in the planning, project development and ordering of the HENSEL ENYSTAR and Mi distribution boards. The professional planning aid enables the distributor to be displayed as a detailed 3D image or as a 2D drawing. The user can differentiate between equipment, covers and doors via different levels in the view.

- + Convenient planning with the 3D configurator
- + Layout creation for the installer
- + Automatic creation of the parts and order list
- + Data export of the layout in dxf format and of the parts list in ASCII or Excel format.
- + Testing of the mechanical assembly incl. automatic necessary additions, e.g. wall seals, busbar connectors etc.
- + Different levels can be displayed, e.g. behind the contact hazard protection cover plate.

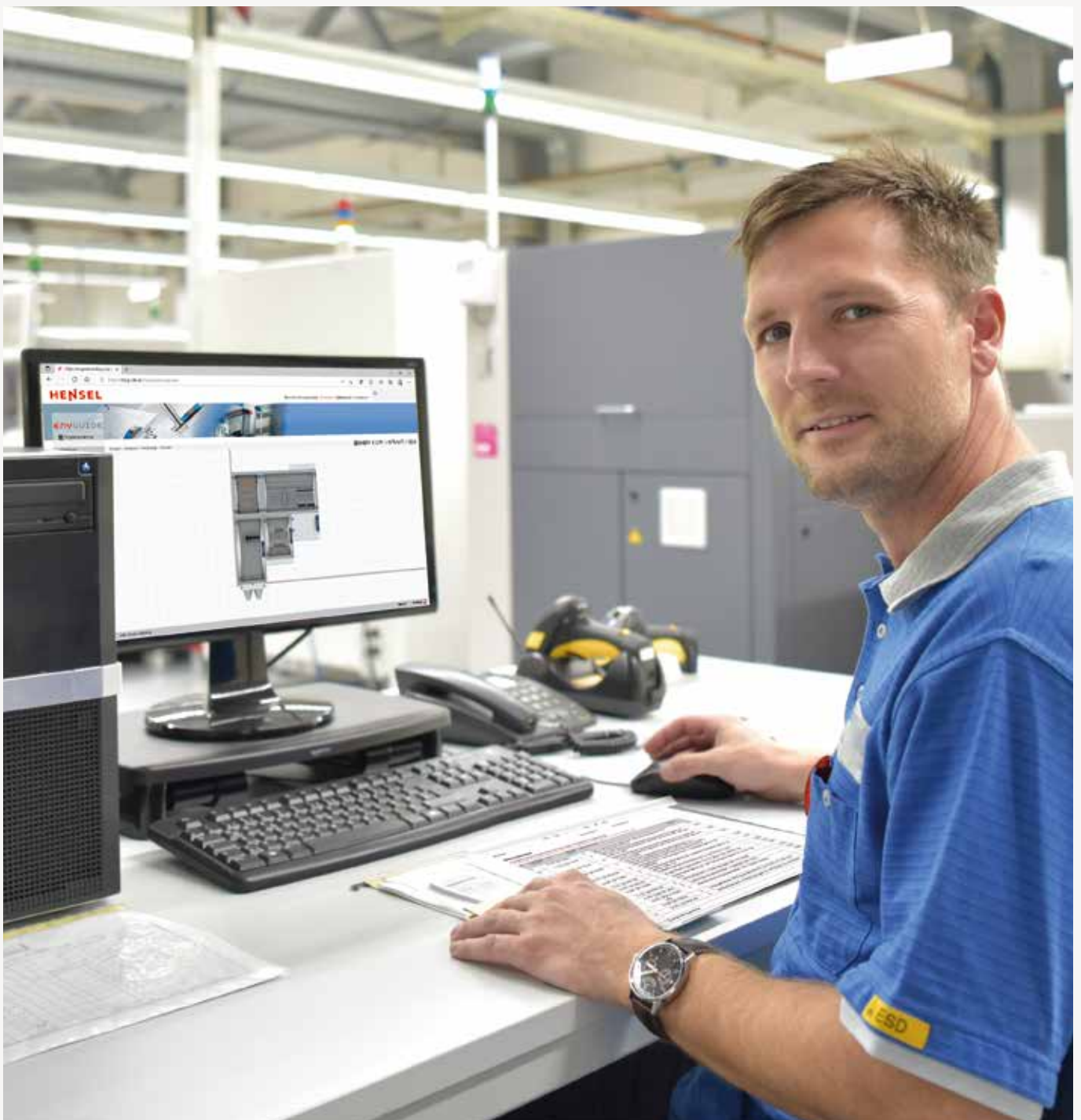

HENSEL ELECTRIC UK LTD.

Ground Floor

Unit 5

Anglo Office Park

Lincoln Road

High Wycombe

HP12 3FU

United Kingdom

Phone: +44 (0)3450 66 00 55

sales@hensel-electric.co.uk

hensel-electric.co.uk